

OPERATING INSTRUCTIONS

MUF 40

ARCTIKO

INDEX	PAGE
Warnings / Safete Precautions.....	3
Warning / Caution.....	4-5
View of the Appliance.....	6
Installing the Appliance.....	7
Before using the Appliance.....	8-9
Operation.....	10-12
Cleaning the Appliance.....	12
Structure of the Appliance.....	13
Problems and solutions.....	14
Moving and reinstalling the Appliance.....	15
Specifications.....	16
Error display during operation.....	17
When power failure occurred during operation.....	17
Parameter lists.....	18-21
Wiring diagram.....	22

Caution

The contents of this user manual may be changed without notice

- All rights are reserved by Arctiko A/S.
- Except in cases permitted by Arctiko A/S, this manual can not be copied, re-issued, or translated into other languages.
- Revised as of April 2011

Please read the user manual before operating or using this product

- Be aware of the following warnings and cautions. Ignoring the following warnings and cautions may cause damage to the equipment and/or user injury. The Appliance should only be operated after reading the manual, and with the user's due care and discretion. Particular care should be taken not to disassemble the product.

 **Warning**
Ignoring this warning may cause damage to the equipment and/or personal injury.

 **Caution**
Special attention is required when using the equipment.









- Place this manual within easy reach of the Appliance for reference purposes.

Warnings / Safety Precautions

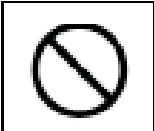
The following marks used on the Appliance and in this User Manual refer to the following contents. Warning stickers with these marks indicate that correct and safe usage of the Appliance is necessary to avoid any risk of personal injury or damage to the Appliance and your property.

Precautions are described under the category 'Warning'/'Caution'. These precautions must be followed closely. Incorrect handling of the product may result in death or serious injury. However, it is important to strictly follow all instructions, not only those in the Warning/Caution category.

Failure to follow instructions may lead to personal injury or death, damage to the Appliance or other property, or breakdown of the Appliance. Please be sure to carefully read and observe all the contents of this manual in order to avoid personal injury and/or damage to the Appliance and your property.

Explanation of Marks used in this Manual		
 Warning/ Caution:	 Caution: Electric Shock	 Caution: Explosion
 Prohibition	 Do not touch	 Do not Disassemble
 Strict Observance	 Pull out Power-Plug	 Grounding Connection Required

* Should the Appliance be transferred to a new location or lent to a different user, please ensure the continuing safe and correct use of the Appliance by placing this user manual where it can be easily found by the next user.





Warning / Caution

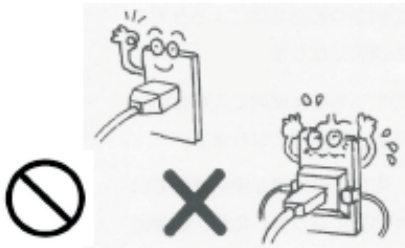

For Correct Usage

- Installation should only be performed by a qualified expert from the sales agency or elsewhere. Imperfect installation may result in electric shocks or fire.
- Place the Appliance on a firm and level floor/desk, which can hold the weight of the Appliance. Imperfect installation or lack of floor/desk strength may cause the Appliance to tilt or fall over, leading to personal injury or damage to the Appliance.
- Be sure to ground the Appliance. Do not ground it to a gas pipe, water pipe, lightning rod, or phone cable. Imperfect grounding may cause electric shocks. (Grounding should only be performed by a qualified electrician.)
- Use an exclusive power outlet for the product. Do not cut and shorten the power cord by yourself. Do not use extension cords, or any kind of electrical outlet divider. Failure to follow these instructions may cause electric shocks, excessive heat-generation, or fire.
- Do not use the Appliance outdoors. Using the Appliance in a place where it can come into contact with water may cause electric leakage and electric shocks.
- Do not install the Appliance in a damp place or any other place where it may come into contact with water. Failure to follow these instructions may cause electric leakage and/or electric shocks, due to lower electrical isolation.
- Do not pour or spill water on the Appliance or wash it with water. Failure to follow these instructions may cause short circuits and electric shocks.
- Do not touch the power plug, switches or any other electrical parts with wet hands. Failure to follow these instructions may cause electric shocks.
- Do not scratch, convert, bend, pull, or tie the power cord. Also, do not put any heavy objects on it. Make sure the cord is not being pinched. Any damage to the power cord may cause fire or electric shocks.
- Make sure that the power plug is cleaned regularly. Make sure the plug is completely inserted into the socket. Dust or dirt on the power plug or incomplete insertion may cause electric shocks or fire
- If a circuit breaker is activated, please consult your sales agency or other qualified experts. Forceful power restoration may cause electric shocks or fire.
- Do not hang on the door. The door may come off the Appliance or the Appliance may fall over, leading to personal injury, or electric leakage and electric shocks.
- Do not place volatile substances or inflammables in the Appliance. These substances may cause explosions or fire.

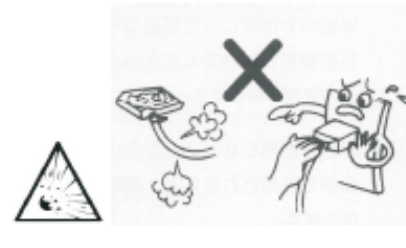
- The disassembling, repairing, or converting of the Appliance by unqualified staff is strongly prohibited. Failure to follow these instructions may cause personal injury, electric shocks or fire, due to malfunctions caused by imperfect repairs.
- In case of malfunctioning, switch off the Appliance, then pull out the power plug or turn the power off at source. Failure to perform these actions when the Appliance shows any signs of malfunction may cause electric shocks or fire.
- When moving the Appliance please consult your sales agency or other qualified experts. Imperfect installation may cause electric shocks or fire.
- When the Appliance is not being used it should be stored away from places where children are present. Ensure that the door cannot be locked. Failure to observe these instructions may lead to people being accidentally locked-in the Appliance.
- When retiring the Appliance please consult a qualified scrap merchant. If the Appliance is not disposed of promptly and correctly, and is left in an unsecured place it may cause an accident such as child-lock-in.

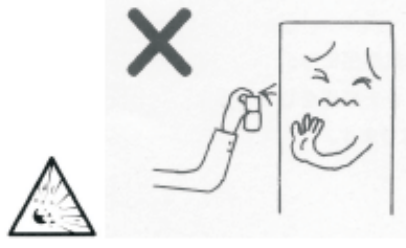
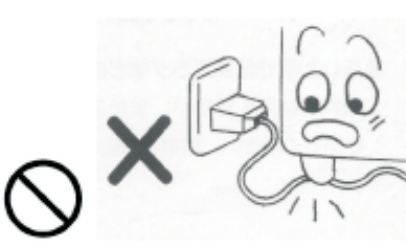
		
<p>Use an exclusive power outlet. Do not use an electrical outlet divider, since this may cause excessive heat generation.</p>	<p>Do not place any inflammables in the Appliance, since they may cause explosions.</p>	<p>In case of gas leakage, do not touch the Appliance. Turn off the gas valve and ventilate the area. Pulling out the power plug may cause an explosion due to the discharge of electric sparks.</p>
		
<p>Keep the Appliance away from water. Failure to do so may lead to electric leakage or electric shocks.</p>	<p>Do not use inflammable sprays or any inflammables near the Appliance, since they may lead to fire</p>	<p>Make sure the power cord is not being pressed on by any other objects, such as an Appliance foot, since this may lead to electric leakage, or damage to the cord due to excessive heat generation.</p>

View of the Appliance

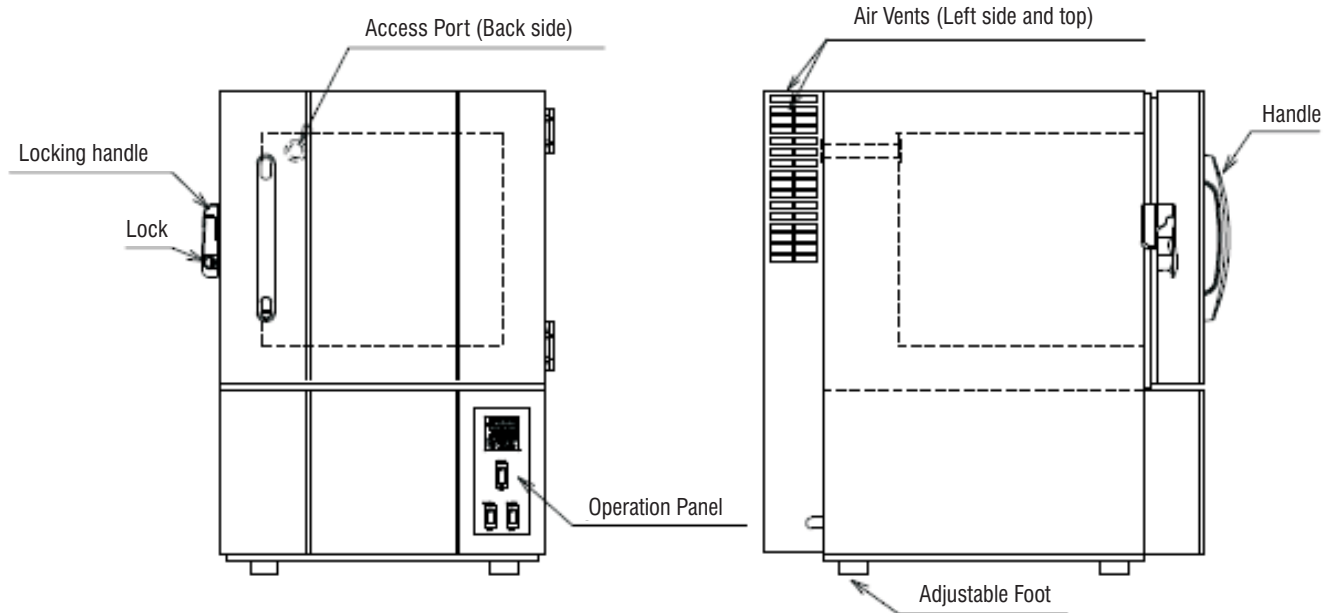

Cooling

- Evaporator is contained in the interior walls of the Appliance. Once it starts operating, frost appears on the interior walls and it cools down gradually.

Heat Radiation

- Heat radiation is performed by the block condenser in the compressor compartment. While the Appliance is cooling down, the block condenser gets hot and heat is radiated by forced air.

Shelves

- Every shelf can be moved up and down with a pitch of 13mm. Place the 4 brackets at the desired height.

Access Port

- There is a porthole in the upper left corner of the interior rear wall of the Appliance, where you can insert temperature sensors. (The inside diameter is 20mm, and the exterior opening is sealed with a rubber plug.)

Operation Panel Cover

- The operation panel is protected by an acrylic resin cover.

Installing the Appliance

- ❗ Installation should only be performed by a qualified expert from the sales agency or elsewhere. Imperfect installation may result in water leakage, electrical leakage, electric shocks, or fire.
- ❗ Choose an area with low levels of both heat and moisture.
 - The cooling performance of the Appliance may be adversely affected if it is placed in direct sunlight or near a source of high temperatures.
 - If moisture or water comes into contact with the Appliance, it may be a cause of poor electrical isolation or rust.
- ❗ Allow adequate space around the Appliance
 - Lack of space may cause poor cooling performance, breakdown of the Appliance, or overuse of electricity.
 - Allow at least 5cm from the back wall of the Appliance, and also at least 5cm from the sidewalls.
 - There should be a space of at least 10cm between the top of the Appliance and the ceiling. There are air vents on the top of the Appliance in the back. Do not place anything on the air vents.

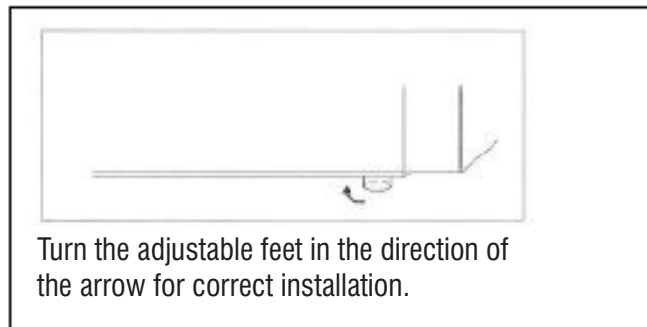
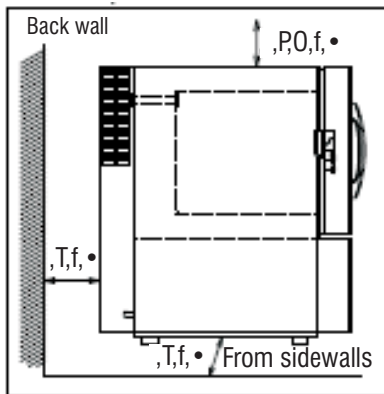

- ❗ Install the Appliance on a firm and level floor/desk
 - To stabilize the Appliance turn the adjustable feet clockwise until they make firm contact with the floor/desk (see figure above, right).
 - If the Appliance is not stabilized correctly, it may cause unusual noises and vibrations.
- ⚡ Ground the Appliance to prevent electric shocks
 - The power plug used on this Appliance comes with a ground. Make sure to use an earthed power outlet. Imperfect grounding may lead to electric shocks.
 - If there is no existing earthed power outlet, it will be necessary to have one installed by a qualified electrician.
- ⊘ Do not connect the grounding conductor to the following objects.
 - Water or gas pipes (This may cause explosions or fire.)
 - Lightning rods or phone cables (This may cause serious injury or death if lightning strikes.)
- ❗ Electric Leakage Breaker
 - If installation in a damp area is unavoidable, the use of an electric leakage breaker is strongly required.
- ❗ Electrical connection must be made in accordance with the local regulations

Before using the Appliance

- !** 1. Install the Appliance on a firm and even floor/desk

 - Install the Appliance on a level floor/desk.
 - The front side of Appliance should be approximately 1cm higher than the back side. Use the adjustable feet to change the level of the front side.
 - !** 2. Position the shelves and clean the inside of the Appliance

 - Set the shelves at the desired height, and clean the inside with a soft and damp cloth.
 - ⊘** 3. Connect the Appliance to an exclusive power outlet

 - Use an exclusive power outlet for the Appliance. Do not cut and shorten the power cord, do not use extension cords, and do not use any electrical outlet divider.
 - Use the correct power supply as indicated on the product label placed on the back of the Appliance. (AC230V, 50Hz, Single phase) Make sure the voltage of the power source meets the specified voltage, $\pm 5\%$. If you have voltage stability problems in your area, use a voltage stabilizer.
 - !** 4. Before storing anything, make sure the inside of the Appliance is fully cooled down



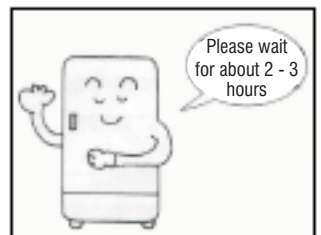
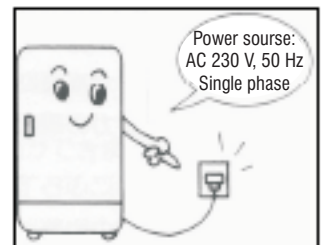
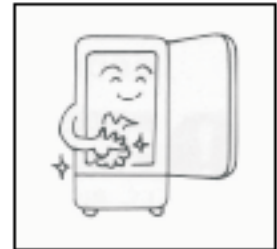
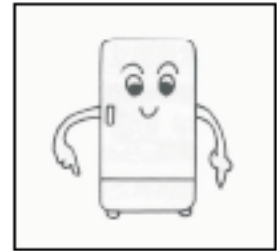















 - The plastic odour will disappear once the Appliance cools down.
- ⊘** If the Appliance is transferred to a new location, and the move takes less than 1 hour, the power supply can be switched on immediately. (Please note that it should not be switched on at least for 10 minutes after it is switched off.) If the transfer takes more than 1 hour, please leave the Appliance unplugged for at least 48 hours with the door open before restarting it.



⚠ Warning/Caution

- ⊘** Do not put bagged ice packs (including those containing ammonium nitrate, and urea) in the Appliance. Leakages from such bags may cause rust or breakdown of the Appliance.
- ⊘** Do not place any form of volatile substance or inflammable, such as ether, benzine, alcohol, propane gas, glue, etc. inside the Appliance. Failure to follow these instructions may lead to explosions or fire.
- ⊘** Any type of bottle or can containing liquid that can be frozen should never be stored in the Appliance since the bottles and cans may explode. This can lead to personal injury.
- ⊘** Do not touch stored materials, containers (especially metallic ones), or the inside of the Appliance with bare or wet hands. Failure to follow these instructions may lead to frostbite. Make sure to wear gloves when working.

Before Using the Appliance (Make sure to read the following warnings)

- 1  If the surrounding temperature is outside the optimum range (5°C~30°C), it may cause breakdown.
- 2  Do not use any inflammable spray, such as lacquer paint, or any form of volatile substances or inflammables near the Appliance. Sparks discharged from the electrical components of the Appliance may ignite such substances leading to explosions or fire.
- 3  In case of gas leakage near the Appliance, turn off the gas valve and ventilate the area. To avoid explosions, do not touch the Appliance or the power plug.
- 4  Do not pour or spill water directly onto the Appliance or wash it with water. Failure to follow the instructions may lead to short circuits or electric shocks.
- 5  Do not touch the electrical components of the Appliance, such as the power plug and the switches, with wet hands. Failure to follow these instructions may lead to electric shocks.
- 6  Do not scratch, convert, bend, pull, or tie the power cord. Also, do not put any heavy objects on it. Make sure the cord is not being pinched. Any damage to the power cord may cause fire or electric shocks.
- 7  When unplugging the Appliance pull on the plug itself. Do not pull the power cord. You may damage the inside wires leading to overheating and fire.
- 8  Use the switch to turn the Appliance on and off. Inserting or unplugging the plug while the Appliance is switched on may cause electric shocks or short circuits.
- 9  After switching off the Appliance, wait for at least 10 minutes before switching it on again. Failure to do so may overload the compressors, causing breakdown. However, please note that the Appliance should be switched on within 1 hour after the power is cut. If you switch off the Appliance for more than 1 hour, please wait for at least 48 hours with the door open before restarting it.
- 10  Make sure that the power plug is cleaned regularly. Always make sure that the plug is completely inserted into the outlet. A dusty or dirty plug or incomplete insertion of the plug may cause electric shocks or fire.
- 11  Please carry out regular checks to ensure that the circuit breaker is functioning correctly. If it is defective, it may lead to electric shocks in the case of electric leakage.
- 12  When a circuit breaker activates, please consult your sales agency or qualified experts. Forceful power restoration may cause electric shocks or fire.
- 13  Do not place any objects or containers containing water on the Appliance. If they fall over, they may cause personal injury and the spilt water may lead to poor electrical isolation and electric leakage.
- 14  Do not put your hands in the compressor compartment as it contains high speed fans and heat-generating parts. Failure to follow these instructions may lead to personal injury.
- 15  Do not hang on the door. The door may come off the Appliance or the Appliance may fall over, leading to personal injury, electric leakage, or electric shocks.
- 16  Do not climb on the Appliance. It may fall over and cause personal injury.
- 17  Do not insert fingers or other objects into the air vents or air intakes. As the fan is spinning at a high speed, it may cause personal injury or breakdown.
- 18  If you do not use the Appliance for a long time, for safety purposes please unplug the Appliance at the outlet. Failure to follow these instructions may lead to dust collecting on the power plug resulting in fire.
- 19  Do not use the Appliance onboard vehicles or any other type of vessel.

Operation

Control Panel

Temperature Controller

The operating temperature can be changed within the operation range.

(Factory setting: -80°C)

1. Once the Appliance is switched on, the display on the controller comes on. (The initial screen will be displayed for 3-4 seconds.)
2. The controller shows the present value (PV) and set value (SV). The set point can be changed by pressing the ▲ and ▼ keys.

⊘ Do not adjust anything other than the set value on the controller, since this may cause malfunction of the Appliance.

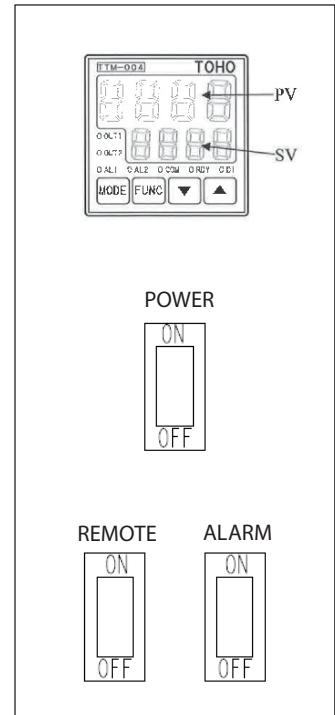



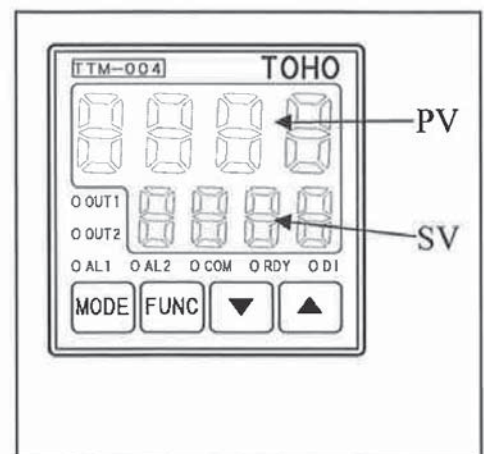

PV	Present value
SV	Setup value
OUT	Light is on when control output is on. (Light is on when the compressor is on.)
AL 1	Light is on when alarm output 1 is on. (Light is on when PV is 15°C or more, higher than SP.)
▲ ▼ Key	Used when changing values. (Values change quickly when the buttons are pressed continuously.)



1. Operation Key Information



Operation Key	Description
MODE Key 	•For change of display (Memorizing the set up parameters when pressing MODE Key)
Function Key 	•Following Practicable functions available for selection. 1) Change of digit All mode 2) AT key Operation mode only 3) Run/Ready key Operation mode only 4) Timer start/Reset Operation mode only
DOWN Key 	•For decrease of setting value (Over 1s and below 10s at continuous press : 1 digit/100ms) (Over 10s and below 20s at continuous press : 10 digits/100ms) (Over 20s at continuous press : 100 digits/100ms)
UP Key 	•For increase of setting value It is the same DOWN Key operation.

2. Operation Flow

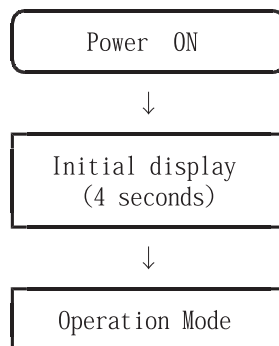

After power ON, it shows " Type of Input display" for 4 seconds and goes on to "Operation Mode"

Power Switch

When this switch is 'on', the display of the temperature controller comes on, and the freezer starts to operate. When it is 'off', the controller display turns off, and the freezer stops its operation.

ALARM Switch

If you turn on this switch, the alarm (Beeping sound) goes off in the following cases:

- When the present value (PV) is 15°C or more, higher than the set point (SP).
- In case of power failure, when the power plug is pulled out, or when the power switch is turned off.

The alarm will sound for about 48 hours continuously with charged batteries even when there is no power supply to the freezer. However, the batteries must be fully charged. (Charged for 5 days or longer.)

- The ALARM switch should be on during freezer operation.
- In order to check the functioning of the alarm buzzer during normal operation, turn off the power switch while the ALARM switch is on. If the alarm goes off, the buzzer is functioning normally.

Operation

- ❗ Check the functioning of the alarm buzzer every 2 months. If the alarm does not go off, please contact your sales agency.
- ❗ The life time of the rechargeable batteries is about 3 years. 2 size-D Nickel-Cadmium batteries are used. Please contact your sales agency for replacements. Batteries must be replaced every 3 years to ensure correct functioning of the alarm.

Remote (Remote Switch)

The terminal for voltage-free external/remote alarms is on the back of the Appliance. To use external/remote alarms, the switch must be on. Wires for external/remote alarms should be connected at the terminal.



* The operation panel is protected by an acrylic resin cover.

Cleaning the Appliance



Before cleaning the Appliance, you must unplug it and take out all the stored materials. Then, open up the door to defrost the Appliance. When defrosting is finished, remove all water with dry cloths. Leave the door open until it is completely dry.

- Prepare lukewarm water containing a small amount of neutral detergent. Soak a cloth in the water, wring it out, and clean the door, shelve, and inner walls, etc. Remove all remaining water with a dry cloth. Keep the door open until it is completely dry. Do not use any polisher.
- Clean the door gasket with water and dry it regularly. Do not use oil or grease, since the gasket may get damaged or ripped.
- To clean the exterior of the Appliance, use any commercially available wax cleaner. However, make sure that the wax does not touch any plastic parts of the Appliance.
- If using a chemical cloth, please follow the manufacturer's instructions and cautionary notices.
- Remove dust from the top-back and side air vents with a vacuum cleaner or brush at least once a year.

Air Vents

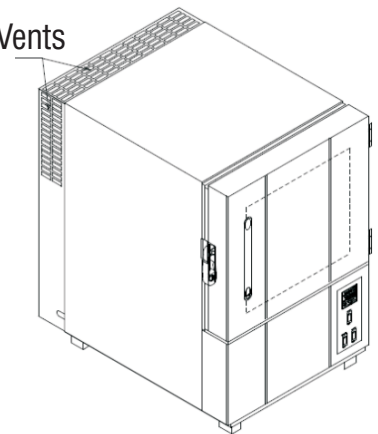

The cooling tubes and the compressor may be very hot. Do not touch any part in the compressor compartment, or you may suffer burns.



Make sure that any electrical parts do not come into contact with water. Failure to follow these instructions may lead to electric leakage or breakdown.



Do not use the following substances;

Thinner, benzene, alcohol, petroleum, powder soap, polisher, alkaline-detergent (Including mild ones), hot water, acid, scrubbing brushes, etc.

- The above mentioned substances may damage the paintwork and plastic surfaces of the Appliance. Alkaline detergents (Including mild ones) in particular may discolor the plastic surfaces.

Structure of the Appliance

1 To open the door
Pull the bottom part of the locking handle forward. Then, pull the handle.



2 To close the door
Close the door. Then, push the locking handle.



! Close the door completely, or the inside temperature may rise and frost around the door may build-up quickly.

3 Shelf
Shelves can be moved up and down.
Take off the brackets and place them at the desired height.



Do not touch stored materials, containers (especially metallic ones), or the inside of the Appliance with bare or wet hands. Failure to follow these instructions may lead to frostbite. Make sure to wear gloves when working.

Problems and Solutions

⊘ Under no circumstances should the Appliance be disassembled, repaired, or converted by unqualified people. Failure to follow these instructions may cause personal injury and/or loss of property due to malfunctions, electric shocks or fire.

⚡ Should the Appliance malfunction, stop the operation, and then pull out the power plug or turn off the power supply at source. Continuing to operate the Appliance when it shows signs of malfunctioning may cause electric shocks or fire.

Check the following.

1. When the Appliance does not cool down at all:
 - Is the power plug fully inserted into the outlet?
 - Is the circuit breaker untripped? Are all the fuses functioning correctly?
 - Has there been a power cut?
 - Is the power switch turned off?

Problems and Solutions

2. When the Appliance shows poor cooling performance:

- Does the set temperature correspond to the desired temperature?
- Is the Appliance placed out of direct sunlight? Is the Appliance placed away from any source of high temperatures?
- Is there enough space around the Appliance for good ventilation?
- Have any materials, which were at room temperature, just been put inside the Appliance?
- Has the door been opened and closed frequently?
- Is the Appliance too loaded?

3. When the Appliance generates unusual noise:

Is the Appliance installed on a firm and level floor/desk?

Is the Appliance levelled properly?

Is there sufficient space between the back and sides of the Appliance and the adjacent walls?





Check the above. If the problem remains, contact your sales agency.

- Type - See the product label placed on the back of Appliance.
- Serial No. - See the product label placed on the back of Appliance.
- Breakdown Symptoms - Describe in as much detail as possible.

The following things may occur naturally during normal operation of the Appliance and do not indicate irregular functioning or breakdown.



- You may hear the noise of water flowing.
This noise comes from the refrigerant circulating around the cooling system. Even when the compressor is not working, there may be a flowing noise. Such flowing noises issuing from the Appliance are normal.
- The door may become heavy or impossible to open immediately after being closed.
When the door is opened, warm air gets into the Appliance chamber and is cooled down rapidly. As a result, the pressure inside the Appliance compartment becomes lower than that outside and a vacuum is created. This is natural. Do not try to open the door forcefully. Wait for some time before opening.
- Condensation appears on the surfaces of the Appliance.
This happens when in conditions of high humidity, when the door is opened and closed frequently, or when the stored materials have high moisture levels. Wipe off the condensation with a dry cloth. Use air conditioners to lower the surrounding humidity.
- The front and sides of the Appliance are warm or hot.
The door frame of the Appliance contain built-in heater that radiate heat and reduce condensation on the frame. The temperature of stored materials is not affected by the regular function of the heater.
- The alarm goes off after putting in or taking out materials.
When large quantities of materials are taken out or put in at the same time, and the door is kept open, the alarm goes off. After a while, the inside temperature will go back to the set value and the alarm will be deactivated. To stop the alarm temporarily, turn off the "ALARM" switch. Do not forget to switch the alarm back on once the temperature is reduced to the set value.

Moving and Reinstalling the Appliance



-  When you need to move the Appliance, consult your sales agency or qualified experts. Imperfect reinstallation may cause electric shocks or fire.
-  When you need to move the Appliance, make sure not to tilt it or let it fall over. Failure to follow these instructions may lead to personal injury and/or property damage.
-  When you need to move the Appliance, pull out the power plug from the outlet, taking care not to damage the power cord. Damage to the cord may lead to electric shocks or fire.
-  Before moving the Appliance, remove all stored materials from the Appliance.
-  When you need to move the Appliance, do not lay it on its side, since this can cause a breakdown.

If the Appliance is transferred to a new location, and the move takes less than 1 hour, the power supply can be switched on immediately. (Please note that it should not be switched on at least for 10 minutes after it is switched off.) If the transfer takes more than 1 hour, please leave the Appliance unplugged for at least 48 hours with the door open before restarting it

The following cases:

-  In case of power cut
 - Limit door openings as much as possible, to keep the temperature down.
 - Do not put any new materials into the Appliance. It will make the inside temperature higher.
 - Dry ice may keep the inside temperature around -50°C for a while.
-  When you wish to dispose the Appliance

Follow these instructions strictly. Failure to follow these instructions may result in child lock-in.

 - Remove the door hinges and the gasket.
 - Do not leave the Appliance in a place to which children have easy access.
 - Contact a qualified scrap merchant for disposal.
-  When you do not need to use the Appliance for a long time
 - Clean the inside of the Appliance and leave the door open for 2~3 days until the inside is completely dry in order to avoid mold or unpleasant odours.
-  When there is any damage, such as scratches, etc. on the painted surface

If you leave the damage as it is, rust will occur. Take action immediately.

 - First remove any rust with sandpaper or a file.
 - Cover the damaged area with any material that will make a water and air-tight seal, so as to prevent the occurrence or re-occurrence of rust.

Specifications

Model	MUF 40
Cooling performance *	Max : -85°C / General operation range : -60°C ~ -80°C
Capacity	35 Litres
External Dimensions (mm)	W495 X D660 X H680
Internal Dimensions (mm)	W336 X D356 X H295
Exterior	EGI Baked Finish
Interior	Stainless Steel 304
Compressor	Hermetic
Condenser	Block Condenser
Refrigerant	EP88 Specially Mixed Refrigerant EP88
Power	AC230V , 50Hz , Single phase
Recommended current capacity	10A or higher
Alarm	Sounds when PV is 15°C or more, higher than SP and in case of power failure
Controller	Temperature Digital
Weight	65kg approximately

- * Cooling performance is measured at +25°C ambient temperature without any load.
- If the Appliances are improved, the specifications may be revised without notice.



Do not convert the Appliance. It may lead to electric shock, or fire.

Error Display during Operation

1

If the controller displays one of the following, carry out the appropriate remedy for the particular error

Display	Error content	Remedy
P.Er	The parameter is abnormal	Check the settings of all the parameters and set them at their proper values.
B.o	Input burnout	Check the sensor wiring and correct it.
000	PV over-scale (PV exceeds its effective range)	Check the input type and range settings and correct them
UUU	PV under-scale (PV falls below its effective range)	
Flashing period on PV display	Communication failure (for /RS option only)	Press any key to stop the flashing

2

The controller needs to be repaired if any of the indications in the table below appear.

In these cases, do not try to repair the controller yourself. Order a new controller or contact us for repair.

When Power Failure Occurred during Operation

Momentary power failures of less than 20ms (or less than 1ms when /V24 is specified) have no effect on the controller operation (i.e., normal operation continues).

For power failures longer than 20ms (or longer than 1ms when /V24 is specified), however the status will be as follows.

(The controller action at power recovery is the same as at power-on)

- Alarm action: Continues (but alarms with a waiting action enter the waiting state once)
- Setting parameters: Maintained
- Auto-turning: Cancelled

How to change parameter in level set1, set2, set3, set7.

1. Press the MODE for 2 sec.
2. Select the desired SET level by pressing the button UP or DOWN
3. Access to the SET level by pressing the MODE button.
4. Scroll between the parameter in the SET level by pressing the MODE button.
5. To change the parameters press the button up or down.
6. Accept the changed parameter by pressing the MODE button.
7. To return to the main menu press the button for 2 sec.

SET 1

Code	Name	Description		Arctiko Default Settings
_InP	Setting for input types	**	Input type	10
		00	K Thermocouple	
		01	J Thermocouple	
		02	R Thermocouple	
		03	T Thermocouple	
		04	N Thermocouple	
		05	S Thermocouple	
		06	B Thermocouple	
		10	Pt 100	
		11	JPT 100	
_PuG	Gain setting for PV correction	Setting range : 0.50 ~ 2.00 Setting unit : doubling		1.00
_PuS	Zero point setting for PV correction	Setting range : -199 ~ 999 or -199.9 ~ 999.9 Setting unit : °C		0
_PdF	Setting for filter input	Setting range : 0 ~ 99 sec.		1
_dP	Setting for decimal position	0	none	0
		0.0	on decimal position	
_FU	Setting function by FUNC Key	0	none	0
		1	Change of digit	
		2	RUN/READY	
		3	AT	
		4	Timer start/Reset	
_LoC	Lock setting	0	OFF	0
		1	All lock	
		2	Lock of operation mode only	
		3	Lock except operation mode	

SET 2

Code	Name	Description	Arctiko Default Settings																						
_SLH	Setting for SV high limiter	Setting range : Low to high limit (Keep 50 digits between high limit of SV limiter and high limit of SV limiter) Setting unit : °C	-50																						
_SLL	Setting for SV low limiter	Setting range : Low to high limit (Keep 50 digits between high limit of SV limiter and low limit of SV limiter) Setting unit : °C	-100																						
_nd	Control mode	Setting for control mode rUn : Control action rdy : Control stop (Manipulated variable low limiter output) nAn : Manual control	rUn																						
_Cnt	Setting of control type	Function <table border="1"> <tr><td>*</td><td>Type</td></tr> <tr><td>0</td><td>Type A</td></tr> <tr><td>1</td><td>Type B (Overshoot protection)</td></tr> </table> Control type of Output 1 <table border="1"> <tr><td>*</td><td>Type</td></tr> <tr><td>1</td><td>PID control</td></tr> <tr><td>2</td><td>ON/OFF control</td></tr> </table> Control type of Output 2 <table border="1"> <tr><td>*</td><td>Type</td></tr> <tr><td>0</td><td>None</td></tr> <tr><td>1</td><td>PID</td></tr> <tr><td>2</td><td>ON/OFF</td></tr> <tr><td>3</td><td>EV output</td></tr> </table>	*	Type	0	Type A	1	Type B (Overshoot protection)	*	Type	1	PID control	2	ON/OFF control	*	Type	0	None	1	PID	2	ON/OFF	3	EV output	020
*	Type																								
0	Type A																								
1	Type B (Overshoot protection)																								
*	Type																								
1	PID control																								
2	ON/OFF control																								
*	Type																								
0	None																								
1	PID																								
2	ON/OFF																								
3	EV output																								
_dl r	Setting for change of normal or reverse	<table border="1"> <tr><td>0</td><td>Reverse</td></tr> <tr><td>1</td><td>Normal</td></tr> </table>	0	Reverse	1	Normal	1																		
0	Reverse																								
1	Normal																								
_nu l	Manipulated value for output 1	Setting for manipulated value monitor output 1 and manipulated value on manual control. Display range : 0. 0 ~ 100 . 0% Setting range : low to high limiter manipulated value.	100.0																						
_CI	Output 1 , control sensitivity	Setting range : 0 to 999 or 0. 0 to 999. 9 Setting unit : °C	1																						
_CP I	Output 1, OFF position	Setting range : -100 to 999 or -1999 to 999. 9 Setting unit : °C	0																						

SET 3

Code	Name	Description	Arctiko Default Settings
_E IF	EV setting/function (PV & Additional event)	PV EV function	2
		2 Type	
		0 None	
		1 Deviation high and low limit	
		2 Deviation high limit	
		3 Deviation low limit	
		4 Deviation high and low limit range	
		5 High and low limit	
		6 High limit	
		7 Low limit	
		8 High and low limit range	
		Additional EV function	
		1 Type	
		0 None	
1 EV Output hold			
2 Stand-by sequence			
3 EV output hold & stand by sequence			
_E IH	High limit setting	Range : -199.9 to 999.9 Unit : °C -1999 ~ 9999	15
_E IC	Setting of EV output sensitivity	Range : 0.0 to 999.9 , 0 to 9999 Unit : °C	0
_E It	Delay timer setting	Range : 0 to 9999 sec.	0
_E Ib	Abnormal SV/heater function setting	2 Type	00
		0 None	
		1 PV EV output normal	
		2 Heater abnormal	
		3 PV EV output abnormal & heater abnormal	
		Additional EV function	
		1 Type	
0 None			
1 EV output hold			
_E IP	Polarity setting of EV output	1 Type	1
		0 Normal Open (NO)	
		1 Normal Close (NC)	

SET 7

Code	Name	Description	Arctiko Default Settings
_tno	Timer output setting		Output type
		0	Non-use timer function
		1	Control
		2	EV output 1
_tnF	Timer function setting		type
		1	Auto-start (on delay)
		2	Manual start (on delay)
		3	EV start (on delay)
		4	Auto-start (off delay)
		5	Manual start (off delay)
		6	EV start (off delay)
		7	SV start (off delay)
_H/n	Timer unit switch	1	Hour, Minute
		2	Minute, Second
_tl n	Time setting	Range : 0:00 to 99:59 (hour, minute) 0:00 to 59:59 (minute, second)	1.00
_tl A	Monitor setting of remaining time	Monitor of remaining time Press FUNC key one time at this display, then timer starts.	0.00

Notes



WWW.ARCTIKO.COM

LAMMEFJORDSVEJ 5
DK-6715 ESBJERG N
DENMARK

TEL. +45 70 20 03 28
FAX. +45 70 20 03 29

INFO@ARCTIKO.COM
WWW.ARC TIKO.COM



50 80 011-06-GB