

OPERATING INSTRUCTIONS

ULUF - Models

The logo for ARCTIKO is a white-outlined pentagon shape, tilted to the right. Inside the shape, the word "ARCTIKO" is written in a bold, green, sans-serif font, oriented vertically.

ARCTIKO

INDEX	PAGE
Before using the appliance	3
Safeguarding the environment	3
Power Failure	3
Precautions and general recommendations	3
Installing the freezer	4
Electrical connection	5
Before commissioning	5
Starting procedure	5
Starting up the freezer	5
Disconnecting the appliance	5
Control Panel	6
Setting icons	7
Custom Settings	8
Advanced Settings	9
Service Settings	10
Advanced Service Settings	10
Status	11
Change / Reset Password	11
Download and upload Data	12
Alarms on display	13
Default settings	14-17
The cooling system	18
CO2 back up	18
Relocating or moving the freezer	18
Cleaning and maintenance of the freezer	19
Spare parts	19
Disposing of the freezer	19
Wiring Diagram	20-22

IMPORTANT

Before using the appliance

For safety reasons, the instructions should be read before the appliance is commissioned.

The operating instructions should always be available and accessible to personnel!

- Low Voltag Directive 2006/95/EEC.
- Electromagnetic Compatibility Directive 2004/108/EEC.
- Only use the freezer for its specific purpose.

Safeguarding the environment

1. Packing

The packing material is entirely recyclable and marked with recycling symbol.

Please follow the local regulations for scrapping.

2. Appliance.

The freezer is made of recyclable material. Dispose the appliance according to the local environmental regulations.

Make the appliance unusable by cutting off the power supply cord. The appliance must be delivered to an authorised centre for recovery of refrigerant.

Appliance

By disposal deliver the appliance to an authorised centre for recovery of refrigerant. Make the appliance unusable by cutting of the power supply cord.

Information

This appliance contains a mixture of various refrigerants. For more information please refer to the rating plate affixed to the freezer.

Power Failure:

The unit is equipped with battery back up for display and contact for remote monitoring only.

Back up time is min. 48 hours, the freezer must be connected voltage in minimum 72 hour before maximum battery is available. Please note the lifetime of the battery is estimated to be 3 years. But should be checked by authorize personnel every 6. Month.

Precautions and general recommendations:

WARNING: Keep ventilation openings, in the appliance enclosure or in the built-in structure, clear of obstruction

WARNING: Do not use mechanical devices or other means to accelerate the defrosting process, other than those recommended by the manufacturer.

WARNING: Do not damage the refrigerant system.

WARNING: Do not use electrical appliances inside the appliance storage compartment, unless they are of the type recommended by the manufacturer.

- Always keep the keys in separate place and out of reach of children.
- Before servicing or cleaning the appliance, unplug it from the mains or disconnect the electrical power supply.
- The power supply cable may only be replaced by an authorised person.
- Frost formation on the interior wall and upper parts is a natural phenomenon, and therefor the freezer should be defrosted during normal cleaning or maintenance.

Appliance with flammable refrigerant:

As the appliance contains a mixture of refrigerants, which are flammable, it is essential to ensure that the refrigerant pipes are not damaged.

Operating Instructions

For safety reasons these operating instructions should be read before the freezer is commissioned. The operating instructions should always be available and accessible to personnel!

The drawings and symbols in these operating instructions are for safety purposes when commissioning and using the freezer.

Instruct personnel in the use of the freezer - the temperature is below -40°C (ULUF60/120/400/500/700/800), -86°C (ULUF15/65/125/450/550/750/850) -90°C (ULUF490/590/890). There is a risk of frost-bite if the contents or parts of the inner container are touched!

In the event of breakdown or irregularities contact professional instructors or repair technicians.

Installing the freezer

1. Always let an authorised electrician install the freezer (read the operating instructions).
2. The freezer should be located in a dry, cool place without direct sunlight. The freezer gives off a great deal of heat when in operation. If the ambient temperature is too high, there is a risk that the freezer will not operate correctly. It is recommended that the room is ventilated, so that the room temperature does not exceed 25°C at most. Class N.
3. Place the freezer on a solid and flat substrate. This will eliminate any vibration and irritating noise. The freezer should be placed with at least 10 cm. free to the sides, at least 15 cm. free at the back.

Electrical connection:

Trouble-free operation, this unit must be properly grounded before it is used. Failure to ground the equipment may cause personal injury or damage to the equipment. Always conform to the National Electrical Code and local codes. Do not connect the unit to overloaded power lines.

Data regarding voltage and absorbed power / current are given on the rating plate placed on the rear side of the freezer.

Electrical connection must be made in accordance with the local regulations. Use of extension cord is not allowed. For installation see wiring diagram.

The machine meets current EU directive.

Low Voltage Directive 2006/95 EEC. Electromagnetic Compatibility Directive 2004/108/EEC.

The machine should be given extra protection in accordance with Electricity Supply Regulations in order to protect the user against dangerous electric shocks in the event of faults.

If the switch is for a three-pin plug, a three-pin plug should be used and the conductor with yellow/green insulation connected to the Earth terminal.

Data regarding voltage and absorbed power/current is given on the rating plate.

For installation see wiring daigram in manual.

Inner doors

NOTE

The inner doors should be used at all times. Make sure to close them tightly.

The manufacturer is not responsible for damage to the freezer caused by failure to do so.

Warning

Regulations require that this appliance be earthed:

The manufacture declines all liability for injury to persons or animals and for damage to property resulting from failure to observe the above procedures and reminders.

If the socket and plug are not of the same type either the socket or the plug must be replaced by a qualified electrician.

Under no circumstances use extension leads or adaptors.

1. The appliance should be connected by an authorised electrician or by the company that sold the appliance. Incorrect installation may damage the appliance.
2. Place the appliance on a flat floor that can bear the weight of the appliance.
3. The electrical installation should be earthed.
4. Do not use extension cables. Connect the appliance directly to a fixed installation. If the appliance is connected to a long extension cable there is a risk that the cable will become hot.
5. The appliance should be placed in a dry location. Do not allow water to come into contact with the cabinet. Water entering electrical parts may cause short-circuiting.
6. In the event of functional or electrical irregularities, please contact an authorised service engineer.

Before Commissioning

Clean the freezer both inside and out using a damp, wrung out cloth. Dry with a dry cloth.

The smell from the plastic parts in the freezer will disappear once the freezer has been cooled down.

Starting procedure

Put the plug in the socket.

The thermostat pre-set by the producer. The appliance should run for at least 6 hours before the thermostat is changed to allow for stabilisation of the cooling system.

Starting up the freezer

Start the freezer. Set the digital thermometer at the temperature required. It will now take about 6-10 hours before the set temperature is reached.

The freezer should be cooled down empty.

When filling the unit with racks/boxes, make sure to pre-cool them in order not to effect the inside temperature of the unit.

Disconnecting the appliance

Electrical disconnecting must be possible either by unplugging the appliance or by means of a double pole switch located up-line from the socket.

Control Panel (G-214 Controller)

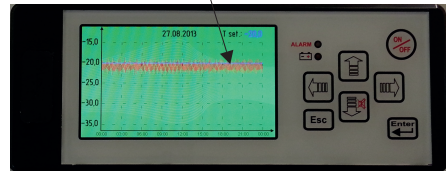
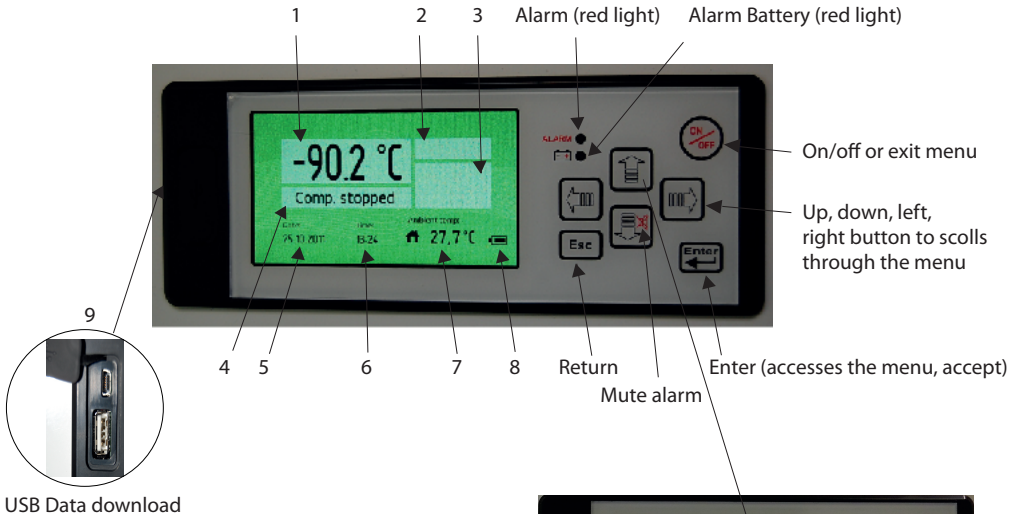

Control Panel Description

1. Temperature indicator
2. Alarm indicator
3. Alarm-icons
4. Compressor indication
5. Date indication
6. Hour indication
7. Ambient temperature indicator
8. Battery level
9. USB-Connection

Push the **UP** button in order to generate a graph.

Push the **LEFT** button in order to return up to 10 days back.

Push the **Esc** button in order to exit the menu.

Setting icons

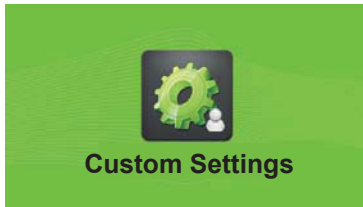

Custom Settings

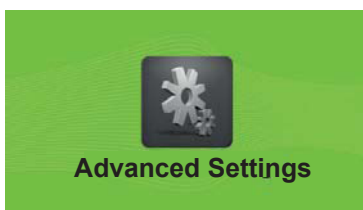

Advanced Settings

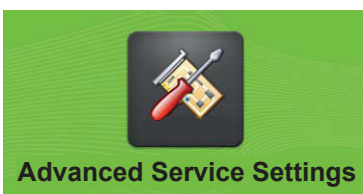

Advanced Service Settings

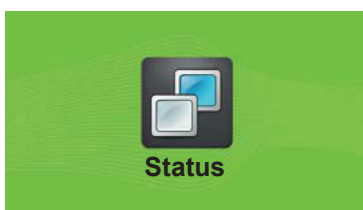

Status

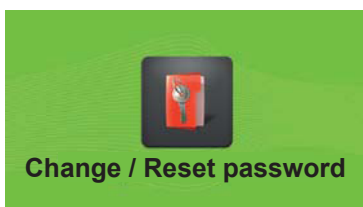

Change / Reset password



Custom Settings



Enter password

The menu **Custom setting** is protected with a password, which is "0000" to access the menu.

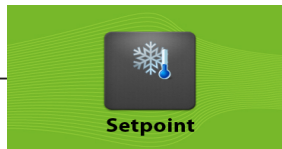

Under the menu **Setpoint** the temperature for the unit will be set.



Under the menu **Alarm Settings** the below menu will be available.



Under the menu **Select language** you can select the desired language.

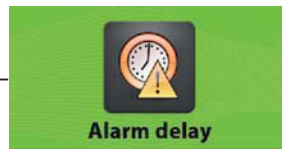

The menu **Alarm delay** is the settings of the time from an alarm will occur on the unit and until it will be shown on the display.

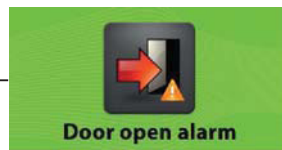

The menu **Door open alarm** is the settings of the time from an alarm will occur on the unit and until it will be shown on the display.

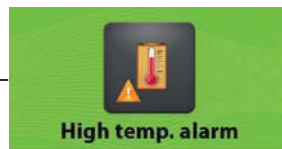

The menu **High temp. alarm** is the settings of the highest temperature the device must be inside before it comes with an alarm.

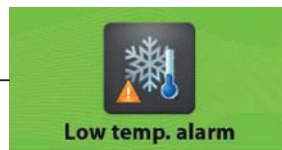

The menu **Low temp. alarm** is the settings of the lowest temperature the device must be inside before it comes with an alarm.



The **Probe eprom failure** alarm indicates that the probe is not working.



The **Power failure** alarm indicates that there is no power to the unit.

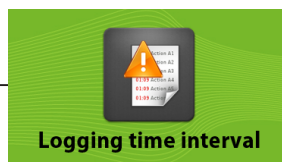

The menu **Log time interval** is the settings of time for the controller to log data from the unit.



Advanced Settings

Advanced Settings



Enter password

Enter password

The menu **Advanced Settings** is protected with a password wich is "0000" to access the menu.



Calibration

The menu **Calibration** is the settings for offset of the temperature in the display.



Automatic defrost

The menu **Automatic defrost** is the setting of the time where a defrost automatic will be performed on the unit.



Manual defrost

Under the menu **Manual defrost** the defrost can be started immediately.



Hysteresis

The menu **Hysteresis** is the setting of the different from the setpoint whwere the compressor will start and stop.



Temp. range limits

The menu **Temp. range limits** is the settings of the maximum and minimum temperature the unit can be used for.



Service

Service

See Page 10



Password protection

The menu **Password protection** is the setting of the protection for the unit not to be turn off and is protected with a password.



Set date / time

The menu **Set date / time** is the setting of date and time.



Ambient temp. settings

The menu **Ambient temp. settings** is the setting of the ambient temperature (min / max.)



Service

Service Settings

Under the menu **Service**, there is information about the unit, which is important for service on the unit.



Compressor hours

The menu **Compressor hours** shows, how many hours the compressor has run.



Fan hours

The menu **Fan hours** shows, how many hours the fan has run.



Probe

Under the menu **Probe** the temperature for the sensor mounted in the unit is displayed.



Probe inside unit

Under the menu **Probe inside unit** the temperature of the sensor mounted inside the unit is displayed. There is mounted one sensor as standard in the unit, but it is possible to mount 3 sensors inside the device/unit.



Probe Compressor

Under the menu **Probe Compressor** the temperature of the sensor mounted on the compressor is displayed. (Not all models)



Probe evaporator

Under the menu **Probe Evaporator** the temperature of the sensor, that is located on the evaporator, is displayed.



Advanced Service Settings

Advanced Service Settings

This menu is only used by the service department at the manufacturer.



Status

Status



Current alarms

The **Current alarms** shows the alarm, which have been on the unit with data and time.



Temp. last 24 hours

The **Temp. last 24 hours** shows the temperature of the unit the last 24 hours.



Change/Reset password

Change / Reset password



Change password

Under **Change password** it is possible to change the password for **Customer Settings**, **Advanced Settings** and **Advanced Service Settings**.



Reset password

Under **Reset password** it is possible to reset the password for the **Customer Settings**, **Advanced Settings** and **Advanced Service Settings**.
Contact the manufacturer to get the password for reset password.

Download Data



Place the USB pen drive in the connection on the display and press the button right for **read data** from the unit to the USB pen.

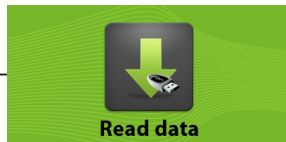

The **Read data** will be shown in the display when the data is loading to the USB pen drive.

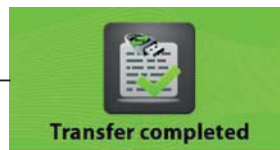

The **Transfer complete** will be shown on the display when the loading is finished and the USB pen can be removed from the display.

Open the 2 files:
data00 and **param00**
 on a computer in Excel or similar.

Upload Data (Only for new settings from the manufactory)



Turn-off the display before start.
 Place the USB pen drive in the connection on the display and press the button left for upload parameters from the USB pen to the unit.

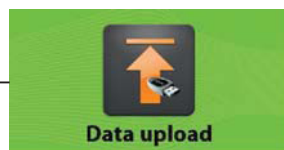

The **Data upload** will be shown in the display when the data is loading to the unit.

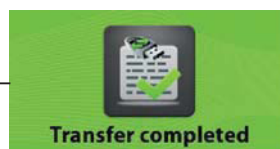

The **Transfer complete** will be shown on the display when the loading is finished and the USB pen can be removed from the display.

Alarms on display



Alarm icons



Door open alarm

The **Door open alarm** indicate, that the door is not correct closed



High temp. alarm

The **High temperature alarm** indicate, that the temperature inside the unit is higher than permitted from setting of the unit.



Low temp. alarm

The **Low temperature alarm** indicate, that the temperature inside the unit is lower than permitted from setting of the unit.



Probe eeprom failure

The **Probe eeprom failure** alarm indicate, that the probe is not working.



Power failure

The **Power failure** alarm indicate, that there is no power to the unit.



Low battery

The **Low battery** alarm indicate, that the power on the battery is to low.

Default settings ULUF 60/120/400/500/700/800:

Description	Arctiko default settings	Customer settings
Custom Settings (Password)	0000	
Set point		
Freezer	-40,0	
Alarm Settings:		
Alarm delay		
Freezer	15 min	
Door open alarm		
Freezer	Enable	
High temp. alarm		
Freezer	-30	
Low temp. alarm		
Freezer	-50	
Probe/eprom failure		
Freezer	Enable	
Power failure		
Freezer	Enable	
Logging time interval		
Freezer	1	

Description	Arctiko default settings	Customer settings
Advanced Settings (Password)	0000	
Calibration		
Freezer	0,0	
Automatic defrost		
Freezer	0	
Manual defrost		
Freezer	OK	
Hysteresis		
Freezer	2,0	
Temp. range limits		
Freezer Max.	-20,0	
Freezer Min.	-40,0	

Default settings ULUF 450/450-2M/550/550-2M/750/750-2M/850/850-2M:

Description	Arctiko default settings	Customer settings
Custom Settings (Password)	0000	
Set point		
Freezer	-80,0	
Alarm Settings:		
Alarm delay		
Freezer	15 min	
Door open alarm		
Freezer	Enable	
High temp. alarm		
Freezer	-70	
Low temp. alarm		
Freezer	-90	
Probe/eprom failure		
Freezer	Enable	
Power failure		
Freezer	Enable	
Logging time interval		
Freezer	1	

Description	Arctiko default settings	Customer settings
Advanced Settings (Password)	0000	
Calibration		
Freezer	0,0	
Automatic defrost		
Freezer	0	
Manual defrost		
Freezer	OK	
Hysteresis		
Freezer	2,0	
Temp. range limits		
Freezer Max.	-40,0	
Freezer Min.	-85,0	

Default settings ULUF 15/65/125 :

Description	Arctiko default settings	Customer settings
Custom Settings (Password)	0000	
Set point		
Freezer	-80,0	
Alarm Settings:		
Alarm delay		
Freezer	15 min	
Door open alarm		
Freezer	Enable	
High temp. alarm		
Freezer	-70	
Low temp. alarm		
Freezer	-90	
Probe/eprom failure		
Freezer	Enable	
Power failure		
Freezer	Enable	
Logging time interval		
Freezer	1	

Description	Arctiko default settings	Customer settings
Advanced Settings (Password)	0000	
Calibration		
Freezer	0,0	
Automatic defrost		
Freezer	0	
Manual defrost		
Freezer	OK	
Hysteresis		
Freezer	2,0	
Temp. range limits		
Freezer Max.	-40,0	
Freezer Min.	-85,0	

Default settings ULUF 490/590/890:

Description	Arctiko default settings	Customer settings
Custom Settings (Password)	0000	
Set point		
Freezer	-80,0	
Alarm Settings:		
Alarm delay		
Freezer	15 min	
Door open alarm		
Freezer	Enable	
High temp. alarm		
Freezer	-70	
Low temp. alarm		
Freezer	-100	
Probe/eprom failure		
Freezer	Enable	
Power failure		
Freezer	Enable	
Logging time interval		
Freezer	1	

Description	Arctiko default settings	Customer settings
Advanced Settings (Password)	0000	
Calibration		
Freezer	0,0	
Automatic defrost		
Freezer	0	
Manual defrost		
Freezer	OK	
Hysteresis		
Freezer	2,0	
Temp. range limits		
Freezer Max.	-40,0	
Freezer Min.	-90,0	

The cooling system

The vaporiser is built into the shelves of the inner container. They will be approx -40°C (ULUF60/120/400/500/700/800), -86°C (ULUF15/65/125/450/550/750/850), -90°C (ULUF490/590/890), so there is a risk of frostbite if they are touched.

Always use thermal gloves when touching the contents of the freezer.

The condenser is placed on top of the cabinet behind the control panel.

Thermostat with digital display: once the freezer is cooled down, the set temperature and the temperature shown will be the same.

CO2 back up

4 x port holes are prepared for CO2 back up, and an injection tube (see separate enclosure) can be inserted from the top of the unit (remove kit). Make sure that pressurized CO2 escape from the gaskets or pressure valve.

Relocating or moving the freezer

Never leave the freezer to others without instructing these people in its use and the safety regulations described in the operating instructions. Always let an authorised electrician install the freezer.

If the freezer and its electrical parts are reconstructed, the guarantee and safety regulations shall cease to apply.

If the freezer does not work: call an authorised servicing engineer!

Contact the distributor or an authorised service repair shop!

Cleaning and maintenance of the freezer:

- Ice will form on the inner doors of the freezer. This ice should be removed with a scraper at regular intervals. (Remember safety gloves).
- Ice on the inside of the cabinet should be removed as required. Take the contents out of the freezer. Pull out the plug and leave the door open until the ice can be removed. (Remember safety gloves).
- Dry the inner cabinet and shelves with a cloth until it is not damp any longer.
- For external maintenance use stainless steel polish.
- Ice formed on the inside of the door should be removed with a wooden/plastic scraper. This ice will build up because of the low temperatures inside the cabinet, and if it is not removed it will cause the door to open.
- Cleansing agents containing chlorine or compounds of chlorine as well as other corrosive means may not be used as they might corrode the stainless panels of the cabinet and the evaporator system.
- The compressor compartment and in particular the condenser must be kept free from dust and dirt. This is best done with a vacuum cleaner and a brush.

Do not put bottles containing carbonic acid or inflammable products in the freezer.

Disposal and scrapping of the freezer: Remove the lock, so that there is no risk of children getting locked in the freezer whilst playing.

Note

Unplug the appliance before carrying out maintenance.

Do not use abrasive products; stain removers (e.g. acetone, trichloroethylene) to clean the appliance

Spare parts

When ordering spare parts that you can easily fit yourself, please give unit type number and the function of the part(s) concerned.

Disposing of the freezer

To prevent harmful environmental effects, contact the distributor and ask where the freezer should be delivered.

Remove the locking function so that children cannot be locked in the freezer whilst playing.

You can obtain information on the disposal of refrigeration appliances from:

- Your supplier
- Authorities (The Local council, Ministry of the Environment, etc.)

Wiring diagram ULUF 400/450/450-2M/500/550/550-2M/700/750/750-2M/ 800/850/850-2M

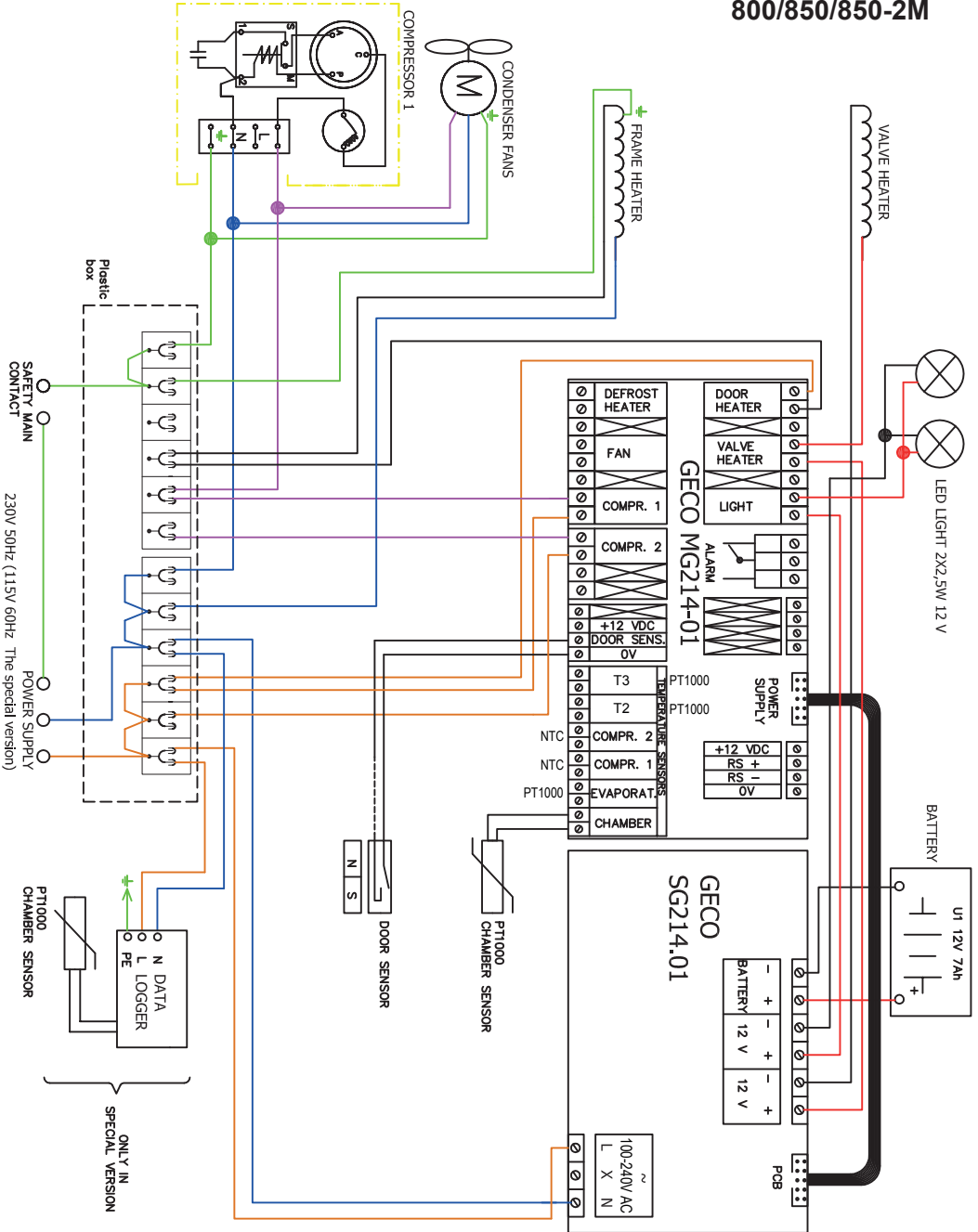

Wiring diagram for ULUF 15/60/65/120/125

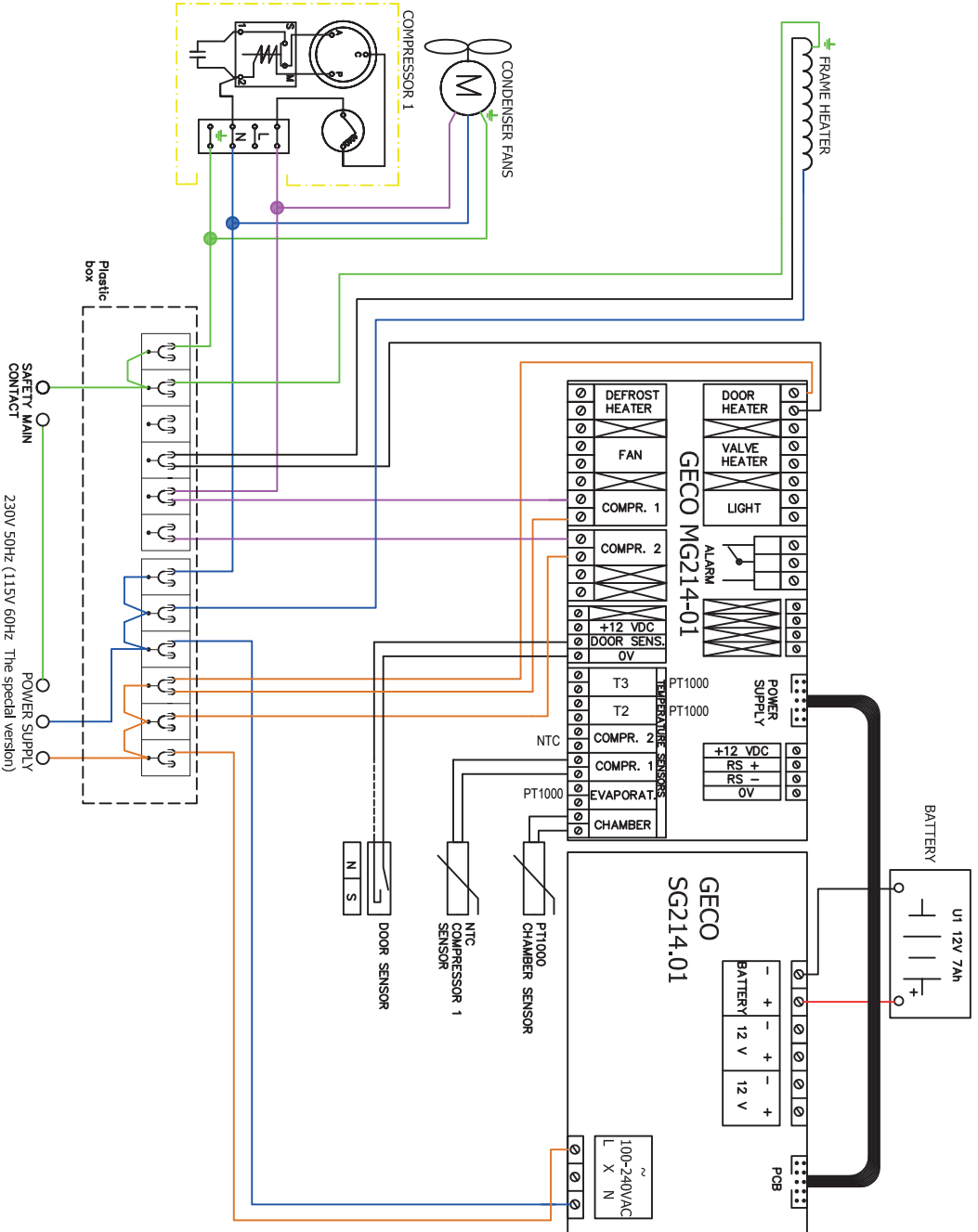

Wiring diagram for ULUF 490/590/890

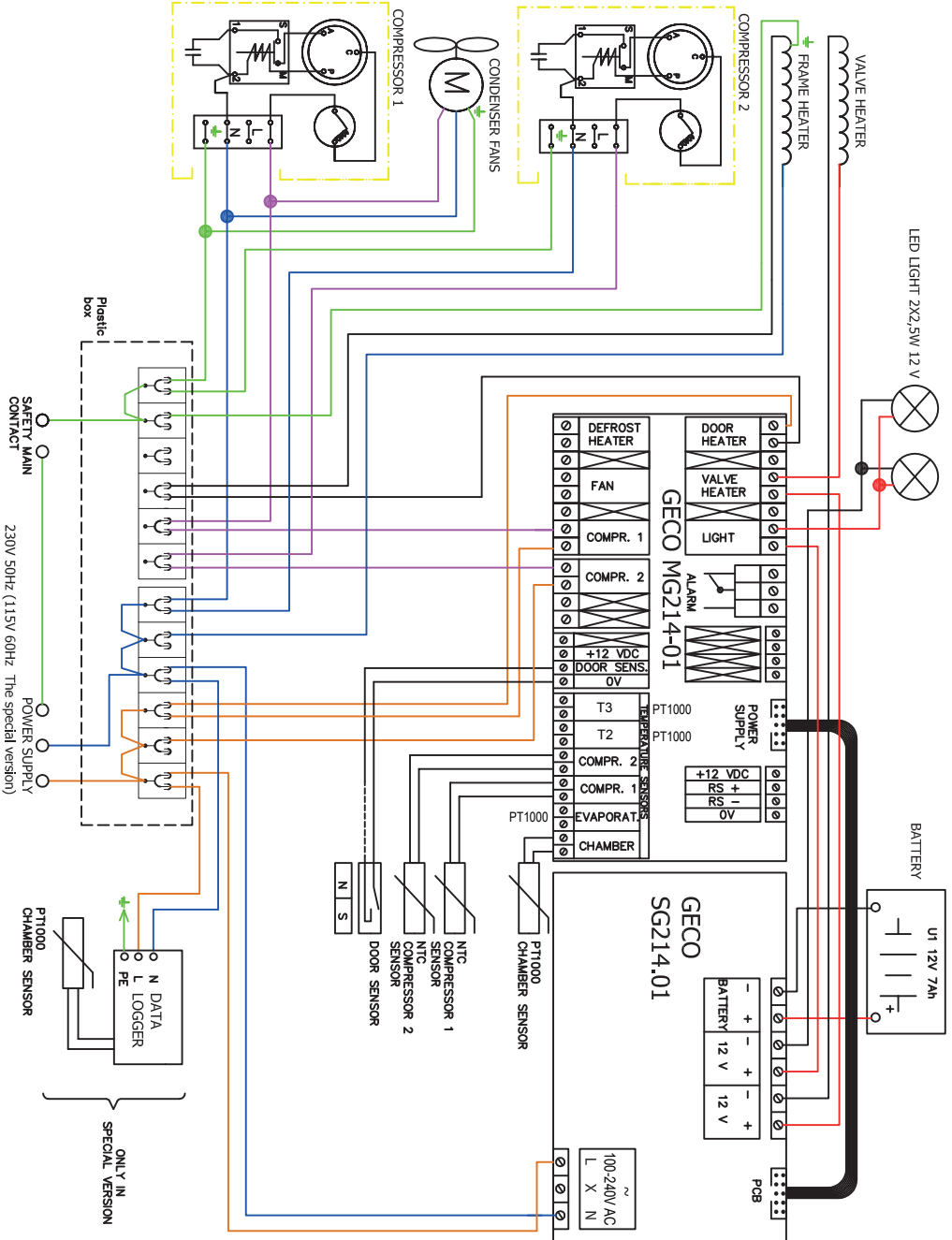

Notes:



WWW.ARCTIKO.COM

LAMMEFJORDSVEJ 5
DK-6715 ESBJERG N
DENMARK
TEL. +45 70 20 03 28
FAX +45 70 20 03 29
INFO@ARCTIKO.COM
WWW.ARCTIKO.COM

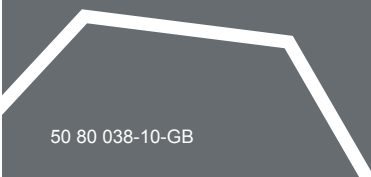

50 80 038-10-GB